

HPM 42 Series

High Pressure Filters



Features

Manufactured from a cast iron head and steel bowl this range of high pressure filters are used in pressure lines to provide system protection from fluid contamination.

Options available include a range of filter elements from 3 micron to 25 micron in both low and high collapse construction in an assortment of media as well as Visual and Electrical/Visual clogging indicators.

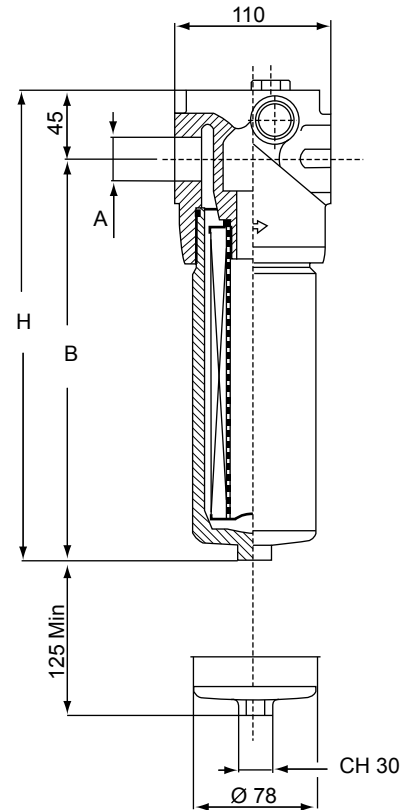
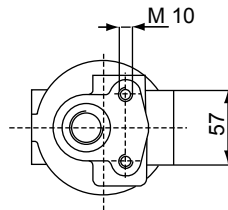
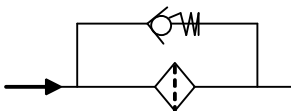
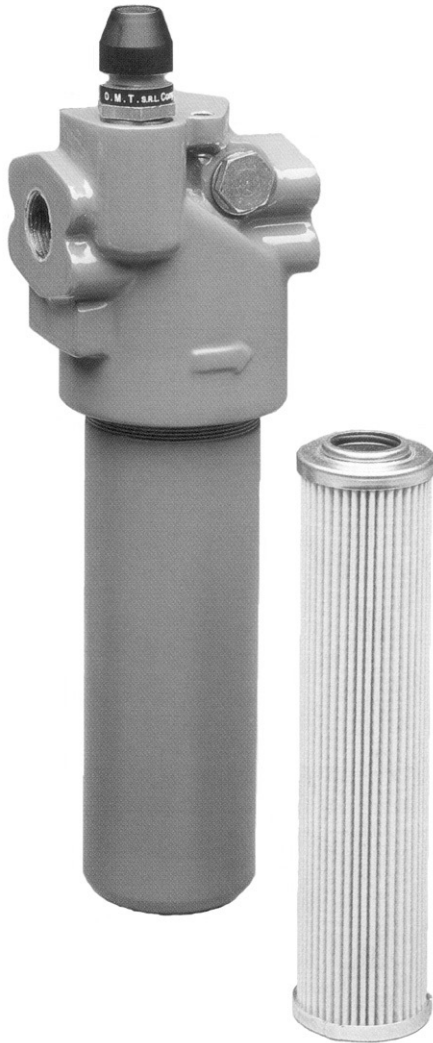

Dimensional Details

Series	Type	A												B	H
		1	2	3	4	5	6	7	8	9	10	11	12		
HPM	421	See connection table in How to Order.												187	230
	422													300	341

HPM 42 Series



High Pressure Filters

How to Order

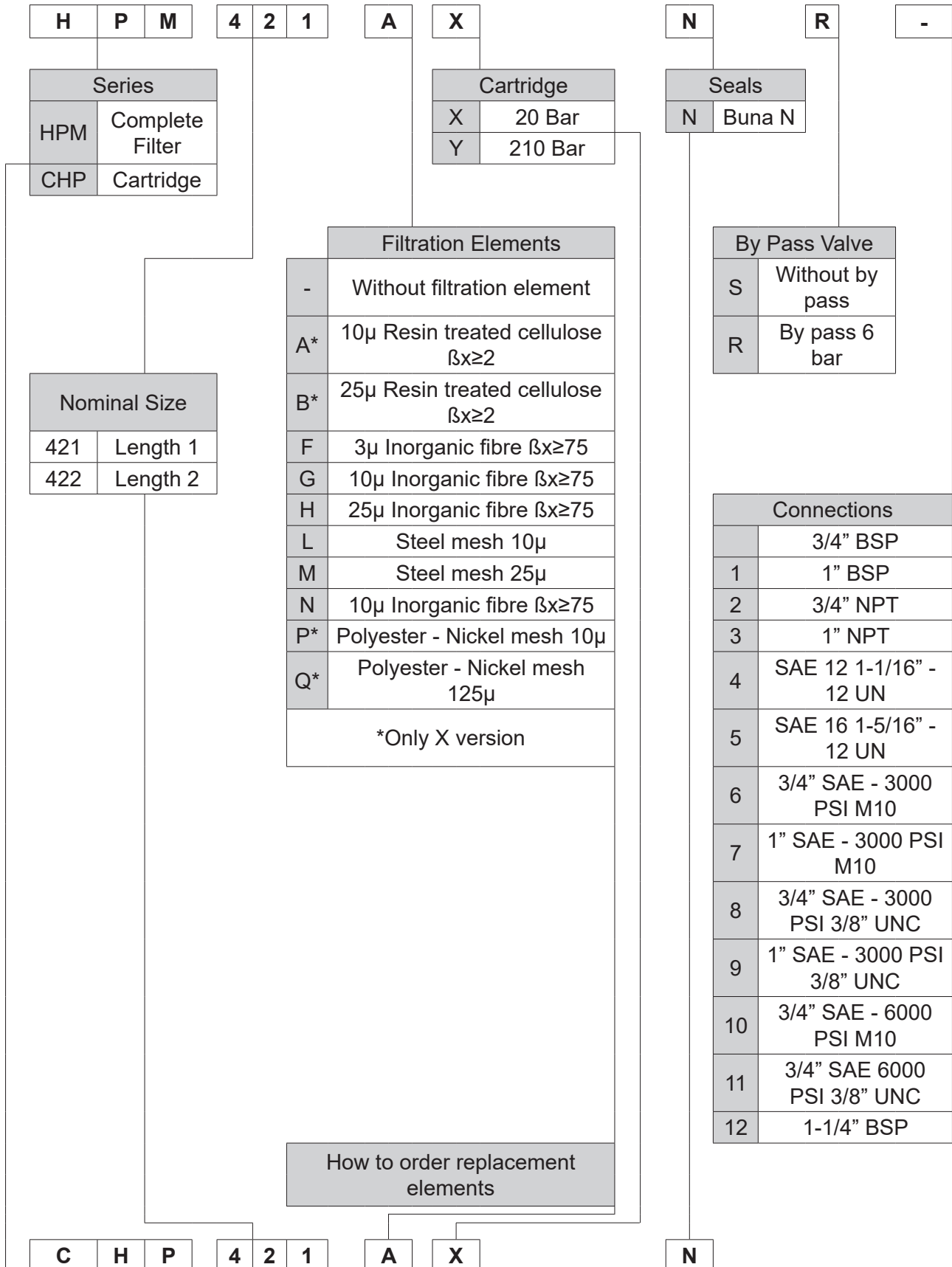

HPM 42 Series

High Pressure Filters



Head pressure drop

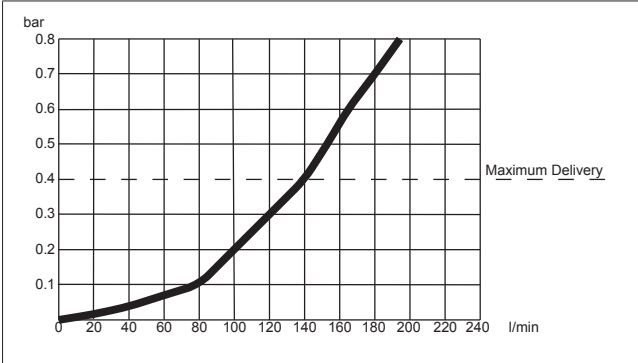

Pressure drop in bypass valve

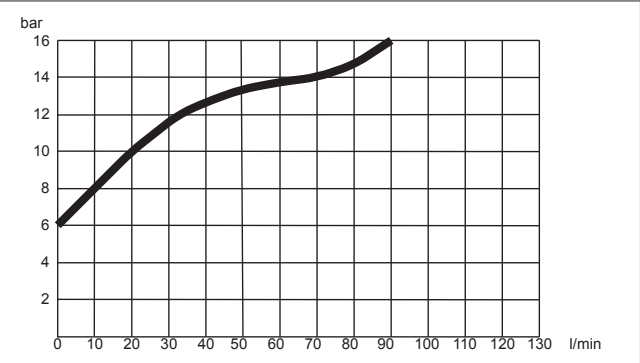

Filter Element Pressure Drop (low differential pressure)

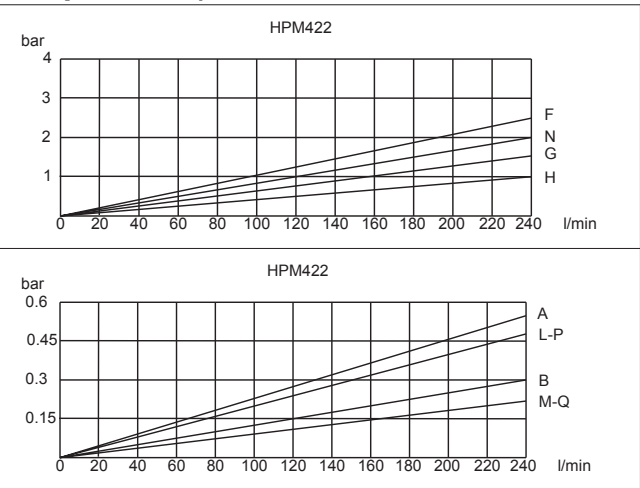
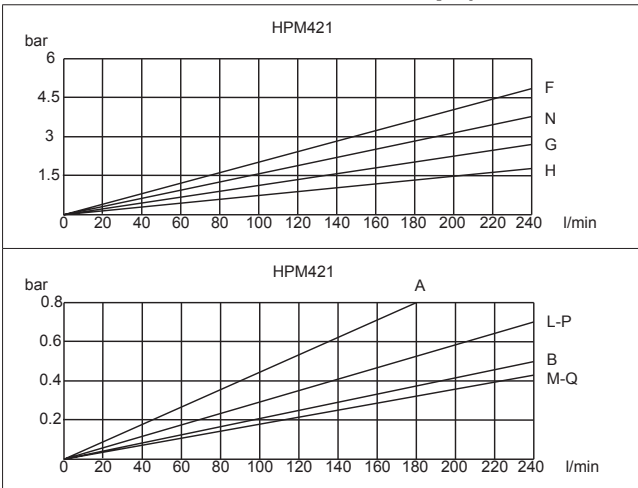

Filter Element Pressure Drop (high differential pressure)

