

# Pipe Clamps

Standard Pipe Clamps



## Features

Standard pipe clamps are a modular assembly suitable for securing tube, pipe and hose in all types of installations.

Because of the modular design, (base plate, top plate, jaw set and securing bolts) either the complete assembly or just the required sub components can be utilised as required in each installation.

## Specifications

Jaws	Polypropylene Polyamide Rubber Aluminium	Standard (Green) Self Extinguishing (Black)  Heavy Duty Series
Upper & Lower Plate Rail	Steel	Gr.FE35
Bolt	Steel	Gr. 4.6 Zinc Plated
Stainless steel components in Gr.304 and Gr.316 can be produced on request.		

# Pipe Clamps

Standard Pipe Clamps

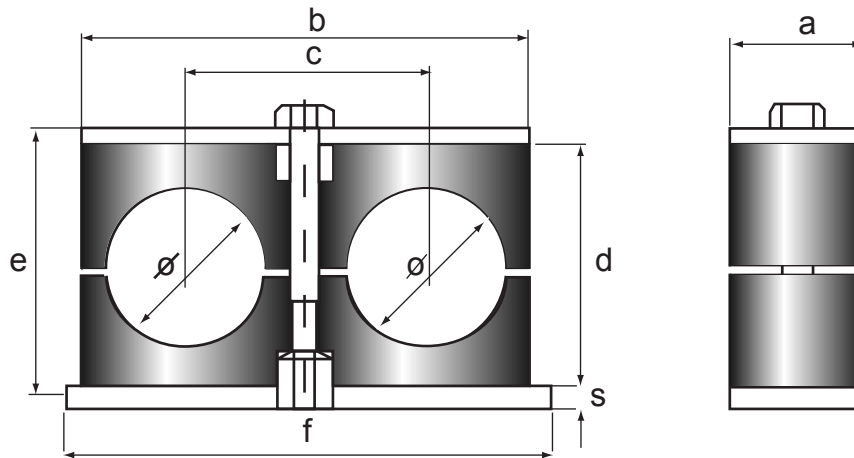

## Assembly Dimensional Details

Group	Pipe Dia mm	Pipe Dia Inches	Stock Code	Dimensions (mm)						
				a	b	c	d	f	s	e
1	6-6	1/4"-1/4" OD	AD106	30	37	20	25	37	3	M6 X30
	8-8	5/16"-5/16" OD	AD108							
	10-10	3/8"-3/8" OD	AD110							
	12-12		AD112							
		1/8"-1/8" NB	AD118"							
2	12.7-12.7	1/2"-1/2" OD	AD2127	30	53	29	26	55	5	M8 X 35
	14-14		AD214							
	15-15		AD215							
	16-16	5/8"-5/8" OD	AD216							
	18-18		AD218							
		1/4"-1/4" NB	AD214"							
3	19-19	3/4"-3/4" OD	AD319	30	67	36	37	70	5	M8 X 45
	20-20		AD320							
	22-22	7/8"-7/8" OD	AD322							
	25-25		AD325							
	25.4-25.4	1"-1" OD	AD3254							
		1/2"-1/2" NB	AD31/2"							
4	28-28		AD428	30	82	45	42	85	5	M8 X 50
	30-30		AD430							
		3/4"-3/4" NB	AD43/4"							
5	32-32	1-1/4"-1-1/4" OD	AD532	30	106	56	54	110	5	M8 X 60
	35-35		AD535							
	38-38	1-1/2"-1-1/2" OD	AD538							
	40-40		AD540							
	42-42		AD542							
	45-45		AD545							
		1"-1" NB	AD51"							
		1-1/4"-1*1/4" NB	AD511/4"							

# Pipe Clamps

Standard Pipe Clamps

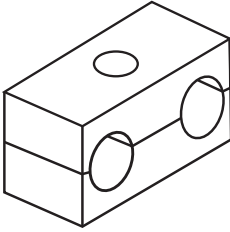
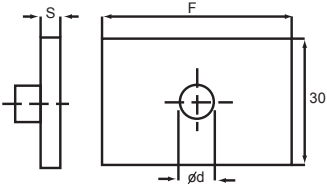
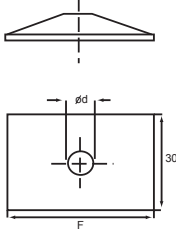
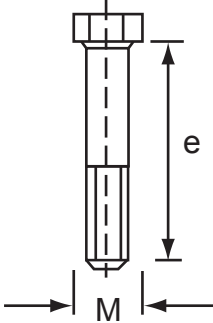

## Standard Double Clamps - Components

 Jaws Part No. (pair) AD***C	 Standard Base Plate Part No. ADPIN*			 Standard Top Plate Part No. ADPS*			 Standard Bolt Part No. ADVTE*		
	F mm	Ød mm	S mm	F mm	Ød mm	M		e mm	
AD106C	37	ADPIN1 12	3	35	ADPS1	7	M6	AVTE2	35
AD108C									
AD110C									
AD112C									
AD11/8"C									
AD2127C	55	ADPIN2 14	5	52	ADPS2	9	M8	ADVTE2	35
AD214C									
AD215C									
AD216C									
AD218C									
AD21/4"C	70	ADPIN3 14	5	66	ADPS3	9	M8	ADVTE3	40
AD320C									
AD322C									
AD325C									
AD3254C									
AD31/2"C	85	ADPIN4 14	5	81	ADPS4	9	M8	ADVTE4	45
AD428C									
AD430C									
AD43/4"C	110	ADPIN5 14	5	105	ADPS5	9	M8	ADVTE5	60
AD532C									
AD535C									
AD538C									
AD540C									
AD542C									
AD545C									
AD51"C									
AD511/4"C									

# Pipe Clamps

Standard Pipe Clamps

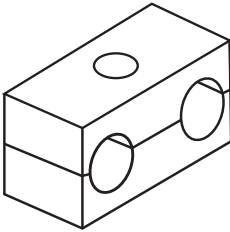
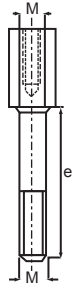
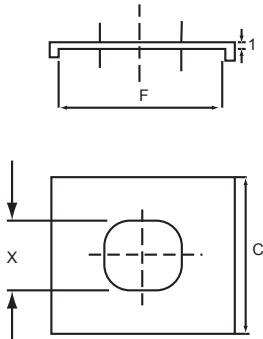
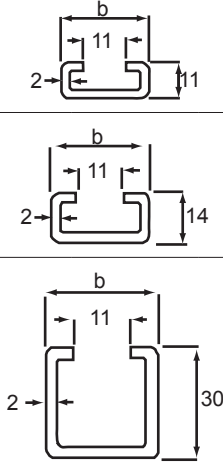
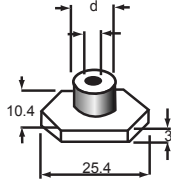

## Multiple & Stacking Standard Components - Double Clamps

Jaws Part No. (pair) AD***C	Stacking Bolt part No. ADVTEA*		Intermediate Plate Part No. APMRSD*			Rail Part No. ABINS*			Rail Nut Part No. ADES		
	M	e mm	F mm	c mm	X mm	b mm	h mm	M	Ød mm		
	    	ADVTEA1	APMRSD1	ABINS1	ADES						
AD106C AD108C AD110C AD112C AD11/8"C	M6	20	30	30	11	28	11	M6	12		
AD2127C AD214C AD215C AD216C AD218C AD21/4"C AD23/8"C	M8	20	30	30	13	28	14	M8	14		
AD319C AD320C AD322C AD325C AD3254C AD31/2"C	M8	29	30	30	13	28	30				
AD428C AD430C AD43/4"C	M8	34	30	30	13						
AD532C AD535C AD538C AD540C AD542C AD545C AD51"C AD511/4"C	M8	47	30	30	13						

# Pipe Clamps

Standard Pipe Clamps



## How to Order

